



# ENERGY STORAGE SOLUTIONS

for Renewable Energy / Hybrid Systems / Backup Power



**Trojan**<sup>®</sup>  
BATTERY COMPANY

*Clean energy for life™*





Imagine a World



**1.2 GWh**  
of installed energy storage worldwide







# of Clean Energy for Everyone.

As the leading manufacturer of deep-cycle batteries, Trojan Battery Company believes it is possible to make a global shift to energy sources that are environmentally friendly and readily available worldwide.

For nearly 100 years, Trojan Battery has focused its experience and expertise in deep-cycle technology on manufacturing the highest quality, deep-cycle batteries available in the industry.

Trojan Battery's world-class development team continually tests and innovates new products, systems, and applications, establishing Trojan's reputation as the world's #1 deep-cycle battery manufacturer.

Our commitment is to our customer. Trojan Battery ensures that our products are made with the highest quality components and always deliver superior performance, durability and reliability.

Essential to Trojan's overall commitment to product quality is our investment in independent third-party testing, which provides

valuable data on product performance while validating Trojan's product reliability and quality. This investment ensures that Trojan delivers the best products available for your application.

## The **Trojan** Advantage

- World's leading manufacturer of advanced deep-cycle battery technology
- Worldwide reputation for best return on investment, durability, performance, and quality components
- Delivers outstanding technical and customer service
- Industry leader in health and safety compliance as well as environmental stewardship
- Made in the USA and available in over 120 countries



# SOLAR

TRUE DEEP-CYCLE BATTERIES



## SOLAR INDUSTRIAL

### Key Features

- Smart Carbon™
- Alpha Plus® Paste with T2 Technology™
- DuraGrid™ Technology
- Reinforced Protection Wrap
- Maxguard® XL Separator
- Moss Shield



## SOLAR AGM

### Key Features

- Alpha Plus® Paste with T2 Technology™
- DuraGrid™ Technology
- Reinforced Protection Wrap
- Premium AGM Separator

### 17 YEARS DESIGN LIFE

Tested to IEC 61427 Standard

### 5-YEAR WARRANTY\*

Free replacement in case of defects in material or workmanship

### EASY MAINTENANCE

Periodic watering required depending on age and usage  
Easy maintenance with optional Watering Kit

### 8+ YEARS DESIGN LIFE

Tested to IEC 61427 Standard

### 3-YEAR WARRANTY\*

Free replacement in case of defects in material or workmanship

### MAINTENANCE-FREE

No watering necessary

### NON HAZARDOUS

Sealed VRLA battery allows for horizontal or vertical installation  
Equipped with flame arrestors  
Non-hazardous, can be air shipped





## SOLAR PREMIUM



### Key Features

Smart Carbon™  
Alpha Plus® Paste  
with T2 Technology™

DuraGrid™ Technology  
Maxguard® XL Separator  
Moss Shield

## SOLAR SIGNATURE



### Key Features

Alpha Plus® Paste  
with T2 Technology™

Trojan Grid Technology  
Maxguard® T2 Separator

### 8+ YEARS DESIGN LIFE

Tested to IEC 61427 Standard

### 3-YEAR WARRANTY\*

Free replacement in case  
of defects in material or  
workmanship

### EASY MAINTENANCE

Periodic watering required  
depending on age and usage  
Easy maintenance with  
optional Watering Kit

### 6 MO. to 1 YEAR WARRANTY\*

Free replacement in case  
of defects in material or  
workmanship

### EASY MAINTENANCE

Periodic watering required  
depending on age and usage  
Easy Maintenance with  
optional Watering Kit  
(most models)



# SOLAR INDUSTRIAL

- Flooded
- 610-2450Ah @ 100Hr
- 17 Years Life\*
- 5-Year Warranty
- Easy Maintenance

\*According to IEC 61427



The Solar Industrial Line is engineered specifically to support renewable energy systems with large daily loads where the batteries are cycled regularly. These high amp-hour capacity batteries are ideal for use in large off-grid photovoltaic (PV) systems, off-grid hybrid PV systems, grid-tied PV systems with battery backup, smart grid peak shifting systems and a variety of other applications. The Solar Industrial Line is tested to IEC standards and features advanced battery technologies that deliver reliable power. Trojan's Solar Industrial Line is the perfect combination of performance and function.

Depth of Discharge vs. Cycle Life in a Stationary Application

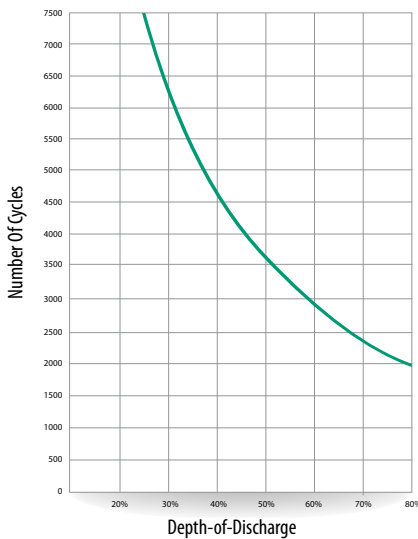

Sustained Capacity over IEC Life Test

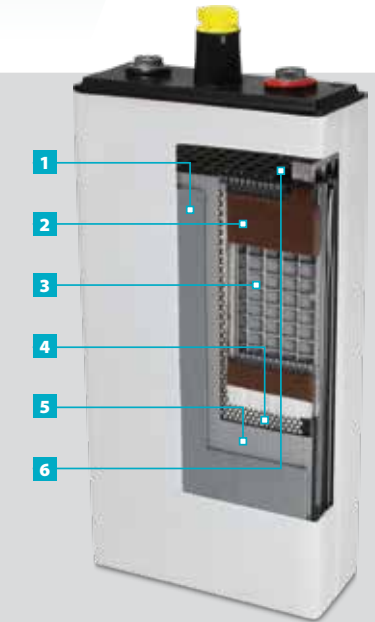
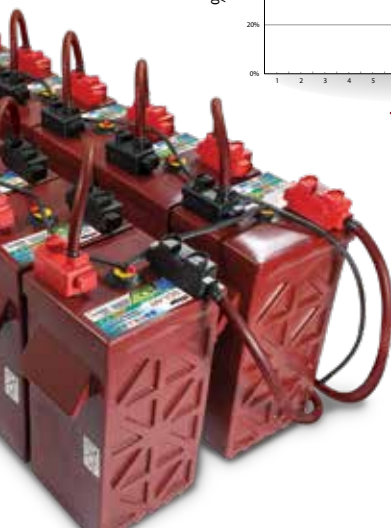
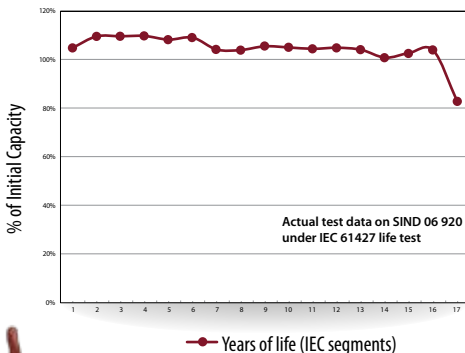

- 1 Smart Carbon™**  
Increases the electrochemically active surface area which provides improved charge acceptance and faster recharge in applications where the batteries may experience Partial State Of Charge (PSOC) on a regular basis.
- 2 Alpha Plus® Paste with T2 Technology™**  
A proprietary, high-density paste formulation precisely engineered to deliver outstanding battery performance.
- 3 DuraGrid™ Technology**  
Features a thick grid structure which maintains greater corrosion resistance, effectively increasing the life of the battery.
- 4 Reinforced Protection Wrap**  
Protects against shedding and assures the electrochemical performance of the battery's active material.
- 5 Maxguard® XL Separator**  
Features a wide-channel design that increases acid flow for optimum battery performance.
- 6 Moss Shield**  
Protects the separators from damage. The moss shield increases the battery life by protecting the top of the plates from shorting to the cell strap.





# SOLAR AGM



- VRLA Sealed
- 105-375Ah @ 20Hr
- 8 Years Life\*
- 3-Year Warranty
- Maintenance-Free

\*According to IEC 61427



Trojan has incorporated several key engineering features in its Solar AGM batteries for renewable energy, hybrid and backup power applications that require deep-cycling power in a non-spillable battery design. Engineered for best value and worry-free storage, Trojan Solar AGM maintenance-free batteries can be counted on day in and day out as a reliable power source for a wide range of off-grid and unreliable grid applications.

Trojan's proven quality and reliability is the result of our extensive engineering expertise in deep-cycle battery design. Our Solar AGM batteries feature:

- Rugged Polypropylene case
- Flame arrestors for safety
- Optimized paste formula for solar applications
- Premium absorbed glass mat separators for maximum performance
- Top-facing or front-facing terminals for easy installation

These combined elements deliver increased total energy output, maximized sustained performance, consistent quality, and enhanced durability. The Trojan Solar AGM batteries are produced at its U.S.-based manufacturing operations which employ the latest technology, testing and quality check standards in the industry.

Depth of Discharge vs. Cycle Life in a Stationary Application

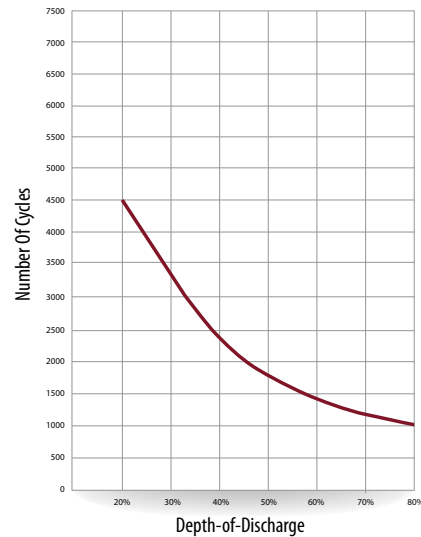

Sustained Capacity over IEC Life Test

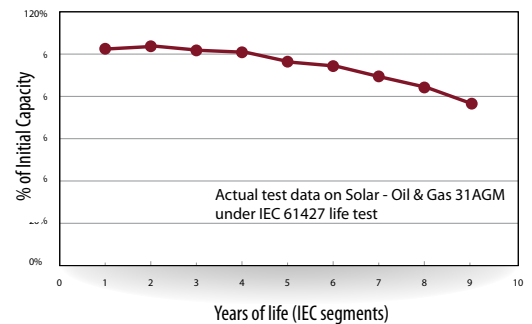

## Most Usable Energy

- Highest Ah and kWh throughput
- Lowest cost of energy over lifetime
- Best overall battery value



# SOLAR PREMIUM



- Flooded
- 225-1255Ah @ 100Hr
- 8 Years Life\*
- 3-Year Warranty
- Easy Maintenance

\*According to IEC 61427



15% MORE CYCLES

IEC 61427

EASY MAINTENANCE

Depth of Discharge vs. Cycle Life in a Stationary Application

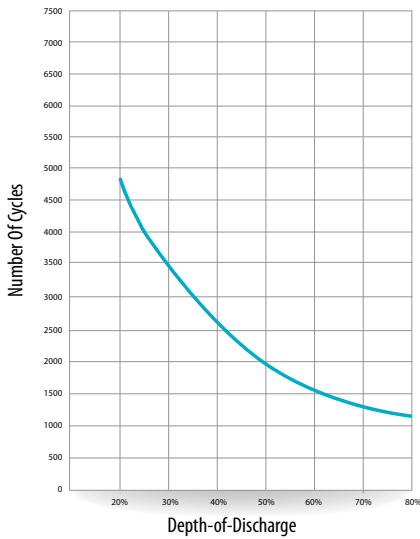

Sustained Capacity over IEC Life Test

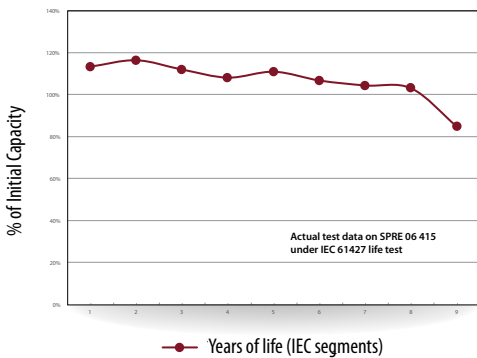

## 1 Smart Carbon™

A proprietary formula of carbon additives designed to enhance battery life and performance.

## 2 Alpha Plus® Paste with T2 Technology™

Optimizes porosity development in the active material resulting in sustained battery performance over a longer period of time.

## 3 DuraGrid™ Technology

Specifically designed for the longer life requirements of renewable energy applications.

## 4 Maxguard® XL Separator

30 percent thicker than our T2 flooded battery separator, and provides even greater resistance to stratification which is typically a mode of failure in batteries used in renewable energy systems.

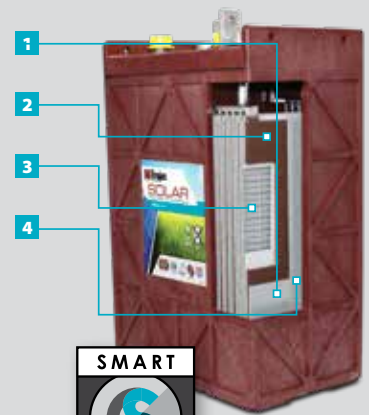



# SOLAR SIGNATURE



- Flooded
- 95-490Ah @ 100Hr
- 6 Months to 1 Year Warranty
- Easy Maintenance



The Solar Signature Line of deep-cycle flooded batteries is engineered to provide rugged durability and outstanding performance. Trojan's Solar Signature Line is perfectly suited for use in renewable energy systems where lowest life-cycle cost is the key consideration. An all-around power house, the Solar Signature Line features Trojan's historically-proven engineering with T2 Technology, an advanced battery technology for maximum sustained performance, longer life and increased total energy.

Depth of Discharge vs. Cycle Life in a Stationary Application

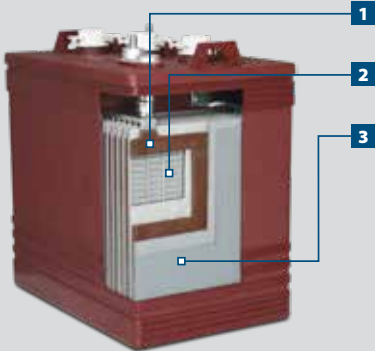
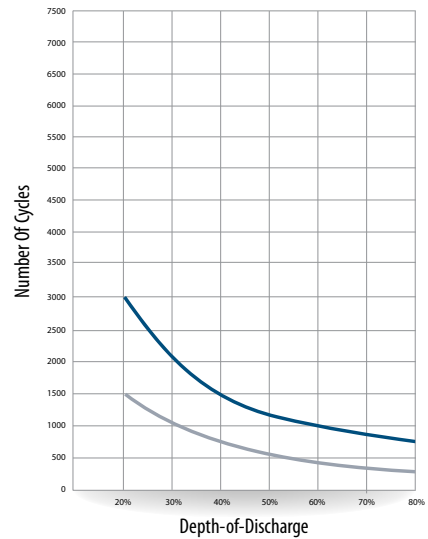

- 1 Alpha Plus<sup>®</sup> Paste with T2 Technology<sup>™</sup>**  
Optimizes porosity development in the active material resulting in sustained battery performance over a longer period of time.
- 2 Trojan Grid Technology**  
Specifically designed for the longer life requirements of renewable energy applications.
- 3 Maxguard<sup>®</sup> T2 Separator**  
30 percent thicker than our T2 flooded battery separator and provides even greater resistance to stratification which is typically a mode of failure in batteries used in renewable energy systems.



# Trojan Engineered Solutions

Advanced Technology				
Technology	Solar Industrial	Solar AGM	Solar Premium	Solar Signature
Smart Carbon™	✓		✓	
Alpha Plus® Paste with T2 Technology	✓	✓	✓	✓
DuraGrid™ Technology	✓	✓	✓	
Trojan Grid Technology				✓
Reinforced Protection Wrap	✓		✓	
Maxguard® XL Separator	✓		✓	
Premium AGM Separator		✓		
Maxguard® T2 Separator				✓
Moss Shield	✓		✓	
Maximum Flame Arrestors	✓	✓	✓	✓
Advanced Lead Acid	✓	✓	✓	
Single-Point Watering Kit	✓		✓	✓
Koroseal protective wrapping	✓			
Overall rugged construction	✓	✓	✓	✓

Engineered and manufactured with the reliability, durability and performance our customers have come to expect.

At Trojan, we are investing at record levels in manufacturing and production improvement projects at our U.S. facilities. Trojan's recent addition of advanced robotics, state-of-the-art cast-on-strap (COS) technology, automated acid fill stations, heat seal and testing equipment ensure the overall quality of our batteries.

## IEC 61427 STANDARD

Secondary cells and batteries for renewable energy storage



**17**  
Years

Trojan Battery  
**Solar Industrial Line**



**8+**  
Years

Trojan Battery  
**Solar Premium Line**



**8+**  
Years

Trojan Battery  
**Solar AGM**

## Importance of testing PV batteries to the IEC 61427 standard

Life expectancy of PV batteries has been difficult to quantify – until now. The International Electrotechnical Commission's (IEC) standard 61427 test provides performance criteria that all batteries for PV applications should be measured against. It offers a common, internationally accepted platform to compare and contrast batteries from different manufacturers.



MODEL NAME	VOLTAGE	CAPACITY <sup>A</sup> Amp-Hours (Ah)					ENERGY <sup>E</sup> (kWh)		DEFAULT TERMINAL	DIMENSIONS <sup>B</sup> Inches (mm)			WEIGHT <sup>D</sup> lbs. (kg)
		10-Hr Rate	20-Hr Rate	48-Hr Rate	72-Hr Rate	100-Hr Rate	100-Hr Rate	Length		Width	Height <sup>C</sup>		
<b>SOLAR INDUSTRIAL LINE - DEEP-CYCLE FLOODED BATTERIES WITH SMART CARBON™ - 3,600 CYCLES @ 50% DOD</b>													
SIND 06 610	6 VOLT	421	472	540	578	610	3.66	14	15.33 (389)	10.22 (260)	24.01 (610)	220 (100)	
SIND 06 920	6 VOLT	627	708	813	870	920	5.52	14	22.34 (567)	10.30 (262)	24.01 (610)	315 (143)	
SIND 06 1225	6 VOLT	835	942	1083	1159	1225	7.35	14	27.13 (689)	10.44 (265)	24.01 (610)	415 (188)	
SIND 04 1685	4 VOLT	1149	1293	1489	1594	1685	6.74	14	22.34 (567)	10.30 (262)	24.01 (610)	367 (167)	
SIND 04 2145	4 VOLT	1474	1647	1896	2030	2145	8.58	14	27.22 (691)	10.44 (265)	24.01 (610)	465 (211)	
SIND 02 1990	2 VOLT	1393	1547	1771	1889	1990	3.98	14	15.33 (389)	10.22 (260)	24.01 (610)	235 (107)	
SIND 02 2450	2 VOLT	1712	1882	2166	2318	2450	4.90	14	17.33 (440)	10.22 (260)	24.01 (610)	278 (125)	
<b>SOLAR PREMIUM LINE - DEEP-CYCLE FLOODED BATTERIES WITH SMART CARBON™ - 1,900 CYCLES @ 50% DOD</b>													
SPRE 12 225*	12 VOLT	179	204	212	216	225	2.70	6	14.97 (380)	6.91 (176)	14.71 (374)	132 (60)	
SPRE 06 255	6 VOLT	211	229	244	249	255	1.53	16	10.30 (262)	7.13 (181)	11.74 (298)	67 (30)	
SPRE 06 415*	6 VOLT	346	377	401	410	415	2.50	5	11.66 (296)	6.94 (176)	17.55 (446)	118 (54)	
SPRE 02 1255*	2 VOLT	1039	1130	1203	1232	1255	2.51	5	11.66 (296)	6.94 (176)	17.55 (446)	119 (54)	
<b>SOLAR SIGNATURE LINE - DEEP-CYCLE FLOODED BATTERIES - 1,200 CYCLES @ 50% DOD</b>													
SSIG 12 170	12 VOLT	136	153	157	164	170	2.04	2	13.95 (354)	7.13 (181)	10.71 (272)	84 (38)	
SSIG 12 230*	12 VOLT	192	209	214	223	230	2.76	6	14.97 (380)	6.91 (176)	14.67 (373)	114 (52)	
SSIG 12 255*	12 VOLT	211	229	237	247	255	3.06	6	14.97 (380)	6.91 (176)	14.67 (373)	123 (56)	
SSIG 06 235	6 VOLT	196	214	220	228	235	1.42	1	10.30 (262)	7.13 (181)	10.74 (273)	58 (26)	
SSIG 06 255	6 VOLT	211	229	237	247	255	1.53	1	10.30 (262)	7.13 (181)	10.74 (273)	62 (28)	
SSIG 06 290	6 VOLT	243	265	271	281	290	1.74	1	10.30 (262)	7.13 (181)	11.48 (292)	72 (33)	
SSIG 06 375*	6 VOLT	309	336	348	363	375	2.25	6	11.66 (296)	6.94 (176)	14.37 (365)	96 (44)	
SSIG 06 405*	6 VOLT	337	366	376	392	405	2.43	6	11.66 (296)	6.94 (176)	14.37 (365)	98 (44)	
SSIG 06 475*	6 VOLT	393	428	441	459	475	2.85	5	11.66 (296)	6.94 (176)	17.55 (446)	114 (52)	
SSIG 06 490*	6 VOLT	407	443	455	474	490	2.94	5	11.66 (296)	6.94 (176)	17.55 (446)	125 (57)	
<b>SOLAR SIGNATURE LINE - DEEP-CYCLE FLOODED BATTERIES - 600 CYCLES @ 50% DOD</b>													
SSIG 12 95	12 VOLT	79	87	88	92	95	1.14	7	10.92 (277)	6.62 (168)	9.25 (235)	47 (21)	
SSIG 12 120	12 VOLT	99	107	111	116	120	1.44	9	12.84 (326)	6.60 (168)	9.74 (247)	55 (25)	
SSIG 12 145	12 VOLT	122	132	135	140	145	1.74	9	13.94 (354)	6.75 (171)	10.09 (256)	66 (30)	
MODEL NAME	VOLTAGE	CAPACITY <sup>A</sup> Amp-Hours (Ah)					ENERGY <sup>E</sup> (kWh)		DEFAULT TERMINAL	DIMENSIONS <sup>B</sup> Inches (mm)			WEIGHT <sup>D</sup> lbs. (kg)
		10-Hr Rate	20-Hr Rate	48-Hr Rate	72-Hr Rate	100-Hr Rate	20-Hr Rate	Length		Width	Height <sup>C</sup>		
<b>SOLAR AGM LINE - DEEP-CYCLE AGM BATTERIES - 1,700 CYCLES @ 50% DOD</b>													
SAGM 12 105	12 VOLT	94	105	109	111	113	1.26	5, 15	12.80 (325)	6.81 (173)	9.34 (237)	67 (30)	
SAGM 12 135	12 VOLT	131	135	136	137	137	1.62	5, 15	12.96 (329)	7.06 (179)	10.96 (278)	83 (38)	
SAGM 12 205	12 VOLT	174	205	210	213	216	2.46	5, 15	14.97 (380)	6.94 (176)	14.07 (357)	131 (59)	
SAGM 08 165	8 VOLT	145	165	168	171	174	1.32	5, 15	10.30 (262)	7.06 (179)	10.73 (273)	70 (32)	
SAGM 06 220	6 VOLT	190	220	228	231	235	1.32	5, 15	10.30 (262)	7.06 (179)	10.73 (273)	68 (31)	
SAGM 06 315	6 VOLT	278	315	326	331	335	1.89	5, 15	11.66 (296)	6.94 (176)	13.99 (355)	95 (43)	
SAGM 06 375	6 VOLT	329	375	389	394	400	2.25	5, 15	11.66 (296)	6.94 (176)	16.31 (414)	114 (52)	



\* Polyon™ Case

- A. The amount of amp-hours (Ah) for Solar Line batteries can deliver when discharged at a constant rate at 86°F (30°C) and maintain a voltage above 1.75 V/cell. Capacities are based on peak performance.
- B. Dimensions may vary depending on type of handle or terminal. Batteries to be mounted with .5 inches (12.7 mm) spacing minimum.
- C. Dimensions taken from bottom of the battery to the highest point on the battery. Heights may vary depending on type of terminal.
- D. Weight may vary.
- E. The Energy (kWh) for the Solar AGM batteries are based on the 20-Hr Rate.

## TERMINAL CONFIGURATIONS



1 - ELPT  
Embedded Low Profile



2 - EHPT  
Embedded High Profile



5 - LT  
L-Terminal



6 - DT  
Automotive Post & Stud



7 - UT  
Universal



8 - AP  
Automotive Post



9 - WNT  
Wingnut



14 - IND  
Ind



15 - M6/M8  
6mm/8mm Insert



16 - SLT  
Small L-Terminal



[www.batterysizingcalculator.com](http://www.batterysizingcalculator.com)

## Configure your Renewable Energy System with Trojan Batteries using the Online Renewable Energy Battery Sizing Calculator

Trojan's battery sizing calculator is an easier way to determine battery capacity than manually calculating load requirements and then converting them to battery capacity. Customers simply fill in the appropriate information on the electronic form such as battery voltage, desired depth-of-discharge (DOD), days of autonomy, AC and DC loads, device types with power ratings, and hours per day or days per week used, and the application automatically determines the required battery capacity. It then recommends the Trojan battery models for their particular application. The calculator also allows customers to run "what if" scenarios to find specific battery options to meet their budget or configuration requirements.

## Environmental Stewardship

At Trojan Battery, when we say, "Clean energy for life™," we mean every word. As proactive supporters of environmental sustainability, our environmental stewardship focuses on clean energy initiatives and recycling programs.



- Trojan batteries are 99% recyclable. The container plastic, battery lead and electrolyte from old deep-cycle batteries can be recycled to produce new deep-cycle batteries.
- Through its partnership with Southern California Edison (SCE), Trojan saves more than 8 million kilowatt hours and cuts CO<sub>2</sub> emissions by over 12 million pounds significantly reducing our annual energy consumption and carbon foot print.

**TROJAN BATTERY COMPANY WITH QUALITY SYSTEM CERTIFIED BY DNV = ISO 9001:2015 =**



Trojan batteries are available worldwide. We offer outstanding technical support, provided by full-time application engineers.

**Call 800.423.6569 or + 1.562.236.3000 or visit [www.trojanbattery.com](http://www.trojanbattery.com)**

12380 Clark Street, Santa Fe Springs, CA 90670, USA or email [marketing@trojanbattery.com](mailto:marketing@trojanbattery.com)

© 2018 Trojan Battery Company, LLC. All rights reserved. Trojan Battery Company is not liable for damages that may result from any information provided in or omitted from this publication, under any circumstances. Trojan Battery Company reserves the right to make adjustments to this publication at any time, without notice or obligation. Please check the Trojan Battery website ([www.trojanbattery.com](http://www.trojanbattery.com)) for the most up-to-date information.